

Electrical Specifications

Frequency Range: 2.0-8.0 GHz
Insertion Loss : 0.4 dB Max.
Isolation: 20 dB Min.
Amplitude Balance: 0.3 dB Max.
Phase Balance: 4.0° Max.
VSWR: 1.40:1 Max.
Input Power: 30 Watt Max.

Mechanical

Mounting Method: Threaded Mounting Holes
Connector Type: SMA
Dimensions: 1.25 x 1.60 x 0.38 in.

Environmental

Operating Temperature: -40 to +85°C
Storage Temperature: -55 to +95°C
Shock: 20 G. 11ms
Vibration: 20 G. 5 to 200 MHz

Outline Drawing:

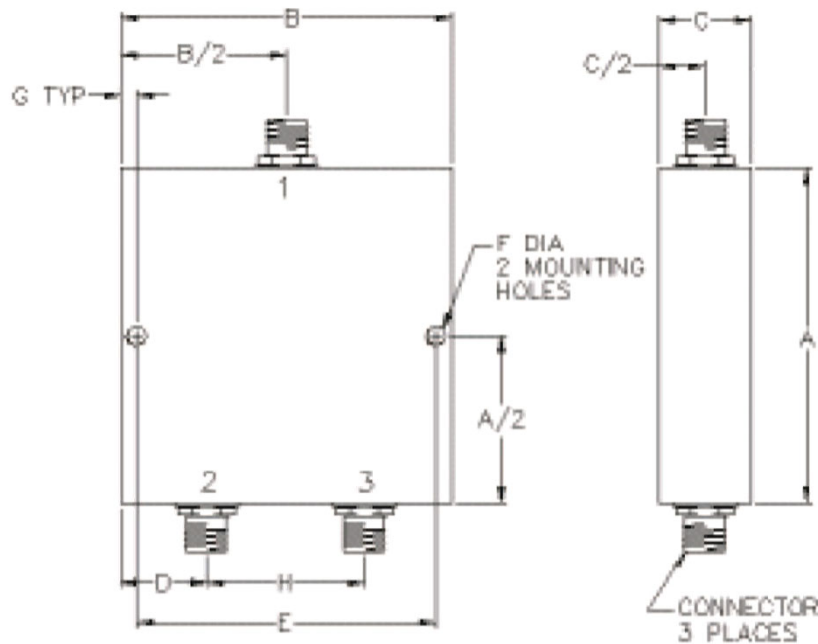

A: 1.60	B: 1.25
C: 0.38	D: 0.38
E: 1.08	F: 0.104
G: 0.10	H: 0.50